

Laurel Electronics Co., Ltd.

SPECIFICATION FOR TFT LCD MODULE

MODEL NO.: LT035B-50D

3.5", 320(RGB) x 240 TFT LCM WITH MCU INTERFACE

자세한 내용은 (주)가나시이스,
TEL: 02-2681-5611로 주시기 바랍니다.

REVISION	PREPARED	CHECKED	APPROVED
0.1	Y.D.Y.	L.Y.J.	L.Y.

RECORD OF REVISION

Date	Revision	Page	Revision Items
2013-07-17	0.1	-	New release. Update schematic and PCB layout from LT035B-50B

자세한 내용은 (주)가나시이스,
TEL: 02-2681-5611로 주시기 바랍니다.

CONTENTS

1. General Description	4
2. Block Diagram	4
3. Interface Specifications	5
4. Absolute Maximum Ratings	6
5. Electrical Characteristics	6
6. Optical Specifications	10
7. Outline Dimension	11
8. Initialization	12
9. Precautions for Use of LCD Module	14

자세한 내용은 (주)가나시이스,
TEL: 02-2681-5611로 주시기 바랍니다.

1. General Description

Item	Specifications	Unit
LCD Type	TFT	-
Display Color	16M	-
Active Area (W×H)	70.08×52.56	mm
Screen Size	3.5(Diagonal)	inch
Number of Dots	320(RGB)×240	dot
Color Configuration	RGB-Stripe	-
Dot Pitch (W×H)	0.073×0.219	mm
Outline Dimensions (W×H×T)	94.0×80.0×9.8	mm
Polarizer Mode	Transmissive	-
Viewing Direction	6 (Gray Scale Inversion Direction)	O'clock
LCD Controller	SSD1926	-
VDD	3.3 to 5.5	V
Int	자세한 내용은 (주)가나시이스, TEL: 02-2681-5611로 주시기 바랍니다.	
Ba		
To		
Operating Temperature	-20 to +70	°C
Storage Temperature	-30 to +80	°C
Weight	62	g

2. Block Diagram

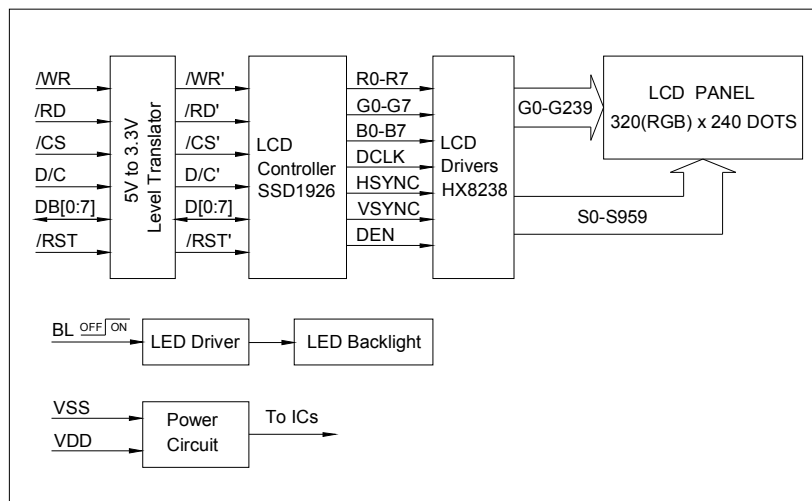

3. Interface Specification (CN1/CN2)

Pin No.	Symbol	Level	Function
1	VSS	0V	Ground
2	VDD	3.3V to 5.5V	Power supply for logic and LED backlight
3	BL	H/L	LED backlight driver enable signal. BL="H": LED backlight on; BL="L": LED backlight off. The LED backlight brightness can be adjusted by a PWM signal applied to BL terminal.
4	D/C	H/L	Data or command selection H: Display data L: Command
5	/WR	L	Write signal. Active "L".
6	/RD	L	Read signal. Active "L".
7	DB0	H/L	
8	DB1	H/L	
12	DB5	H/L	
13	DB6	H/L	
14	DB7	H/L	
15	/CS	H→L	Chip enable signal. Active at falling edge.
16	/RST	L	Reset signal. Active "L"
17-22	NC	-	No connection
23-26	NC	-	No connection

자세한 내용은 (주)가나시이스,
TEL: 02-2681-5611로 주시기 바랍니다.

Note: Pin 23 to Pin 26 is only available for CN1

4. Absolute Maximum Ratings

Item	Symbol	Condition	Min	Max	Unit	Remark
Input Power Supply	VDD	-	-0.3	5.5	V	Logic and Backlight
Input Voltage	Vi	-	-0.3	VDD+0.3	V	

5. Electrical Characteristics

5.1 DC Characteristics (Ta=25°C)

Item	Symbol	Condition	Min	Typ	Max	Unit
Power Supply	VDD		3.3	5.0	5.5	V
Input High Voltage	VIH		2.0	-	VDD	V
Input Low Voltage	VIL		0	-	0.8	V
Output High Voltage	VOH	IOH=-0.1mA	VDD-0.2	-	VDD	V
O C 자세한 내용은 (주)가나시이스, (E TEL: 02-2681-5611로 주시기 바랍니다.						
Current Consumption (Backlight is turned off)	IDD	VDD=5V	-	50	50	mA
		VDD=3.3V	-	50	60	mA

5.2 LED Backlight

The LED backlight is driven by a LED driver IC. With the PWM signal applied to the BL pin, the LED driver IC is turned on or off by the PWM signal. The LEDs operate at either zero or full current. The average LED current increases proportionally with the duty cycle of the PWM signal. A 0% duty cycle will turn off the led driver and corresponds to zero LED current. A 100% duty cycle corresponds to full current. The typical frequency range of the PWM signal should be 1 KHz or less due to the soft start function.

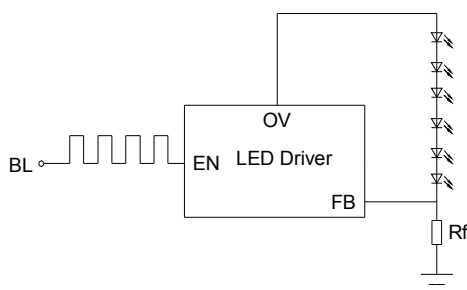

5.3 8080 8-bit Indirect Interface Timing Diagram (Write Cycle)

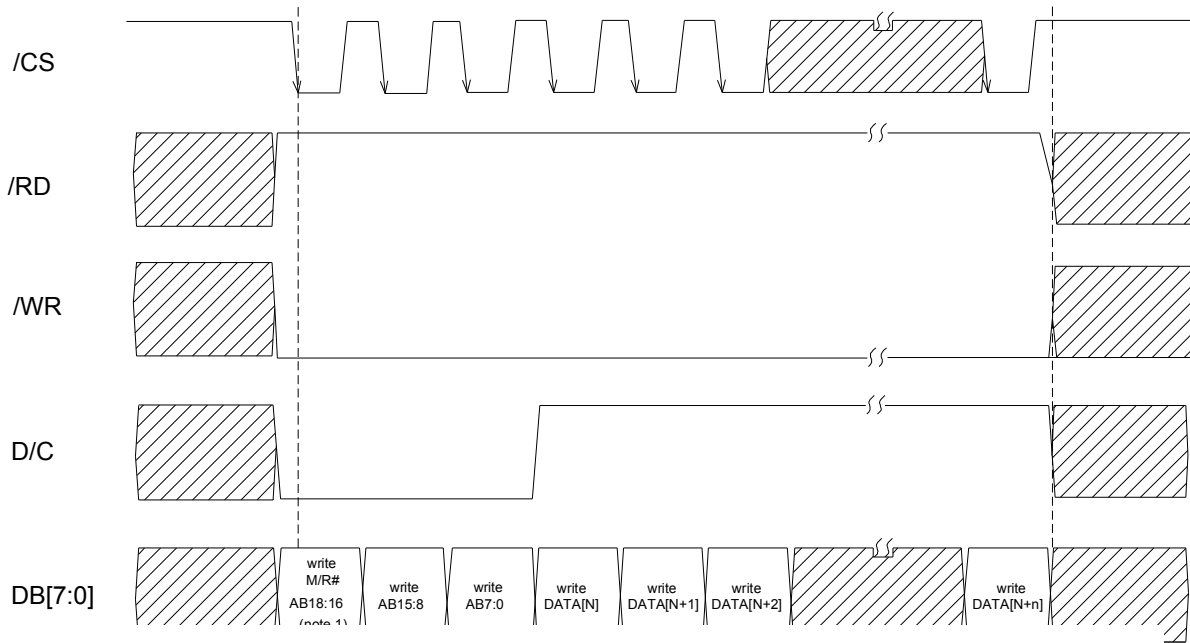

자세한 내용은 (주)가나시이스,
TEL: 02-2681-5611로 주시기 바랍니다.

No

1. Bit 7 represents the M/R#, Bit7=1 means memory access, Bit7=0 means register access.
Bit 6:3=0.
Bit 2:0 represent the address AB(18:16).

5.4 8080 8-bit Indirect Interface Timing Diagram (Read Cycle)

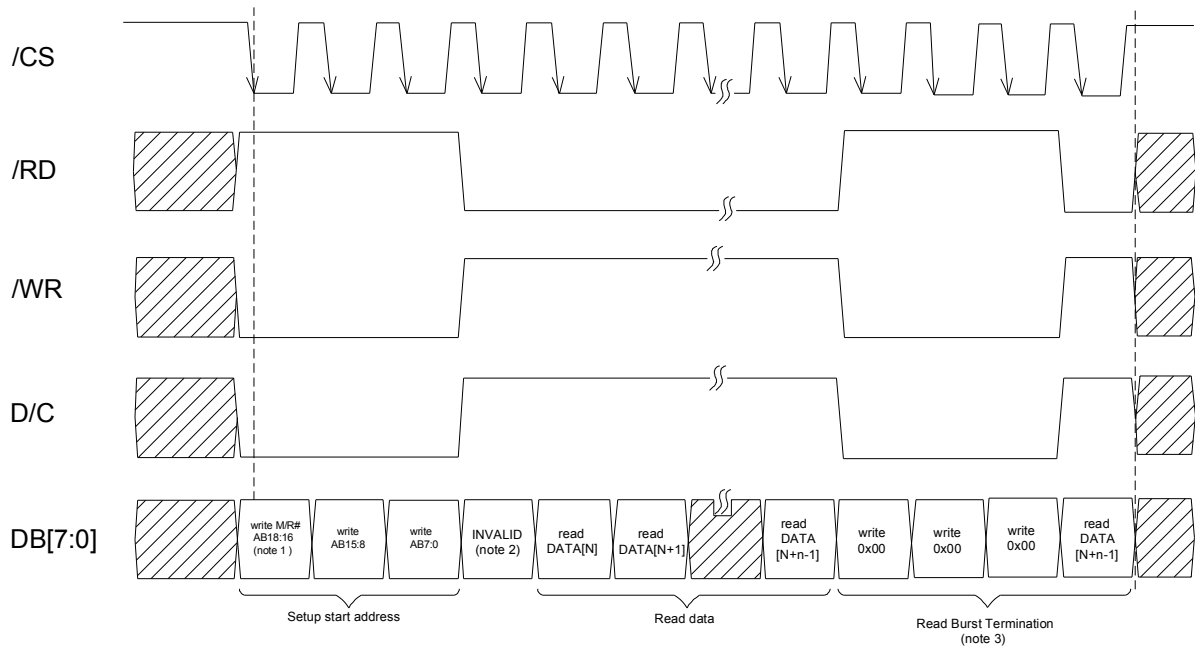

No 자세한 내용은 (주)가나시이스,
 1.1 TEL: 02-2681-5611로 주시기 바랍니다.

f

Bit 2:0 represent the address AB(18:16).

2. Invalid dummy read cycle is needed after address is written.

3. Read Brush Termination must be asserted for all JPEG related memory access.

5.5 8080 Indirect Interface Timing

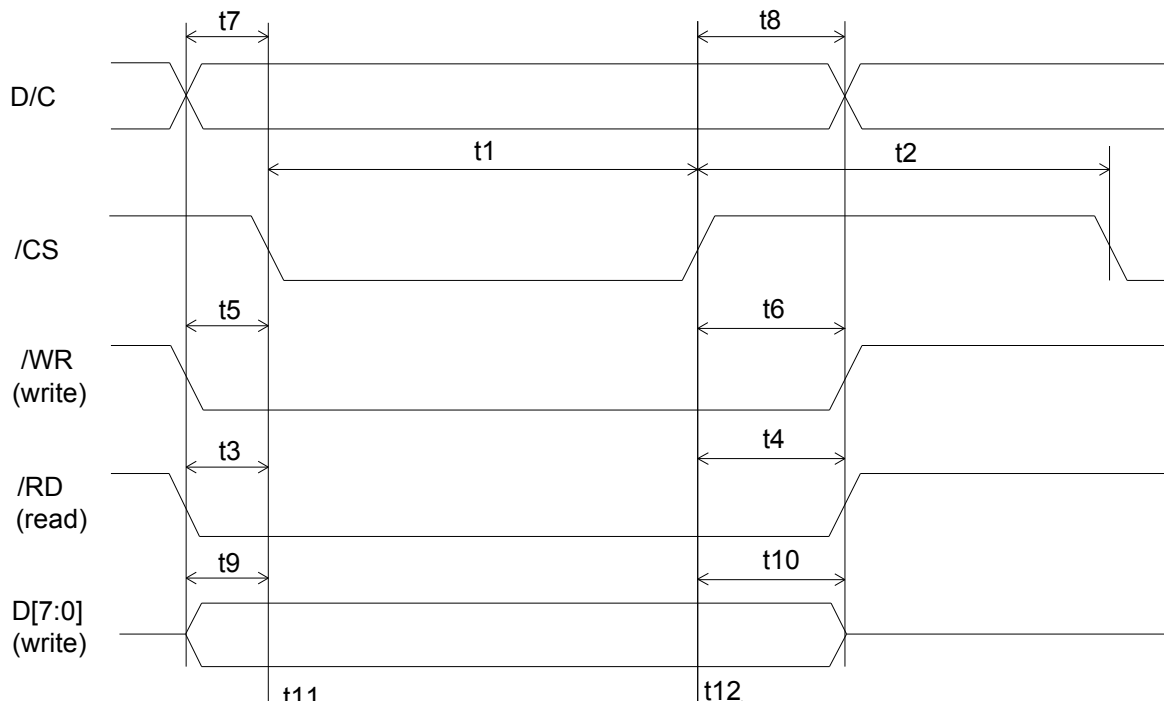

☞ 자세한 내용은 (주)가나시이스,
TEL: 02-2681-5611로 주시기 바랍니다.

Symbol	Parameter	Min	Max	Unit
t1	/CS pulse width low	82		ns
t2	/CS pulse width high	82		ns
t3	/RD setup	18		ns
t4	/RD hold	0		ns
t5	/WR setup	18		ns
t6	/WR hold	0		ns
t7	D/C setup	18		ns
t8	D/C hold	0		ns
t9	D[7:0] setup for write	18		ns
t10	D[7:0] hold for write	0		ns
t11	D[7:0] delay for read	55		ns
t12	D[7:0] hold for read	0		ns

6. Optical Specifications

Item	Symbol	Condition	Min.	Typ.	Max.	Unit	Note
Brightness	-	-	-	150	-	cd/m ²	1
Viewing Angle	Hor.	Θx+	-	60	-	deg.	2
		Θx-	-	60	-		
	Ver.	Θy+	-	50	-		
		Θy-	-	55	-		
Contrast Ratio	Cr	Θx=Θy=0	220	300	-	-	3
Response Time	Tr	Θx=Θy=0	-	10	-	ms	4
	Tf		-	15	-	ms	
Chromaticity	White	x	0.26	0.31	0.36	-	-
		y	0.28	0.33	0.38	-	

Note 1: Measured at the center area of the panel when the LCD on the "White" state.

Note 2: The above "Viewing Angle" is the measuring position with largest contrast ratio, not for good image quality. Viewing direction for good image quality is 6 O'clock.

Normal

자세한 내용은 (주)가나시이스,
TEL: 02-2681-5611로 주시기 바랍니다.

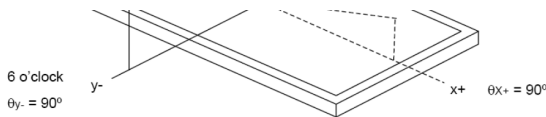

Note 3: The contrast ratio is defined as the following expression.

$$\text{Contrast Ratio (Cr)} = \frac{\text{Brightness measured when LCD on "White" State}}{\text{Brightness measured when LCD on "Black" state}}$$

Note 4: The response time is defined as the LCD optical switching time interval between "White" state and "Black" state. Rise time Tr is the time between photo detector output intensity changed from 90% to 10%. Fall time Tf is the time between photo detector output intensity changed from 10% to 90%.

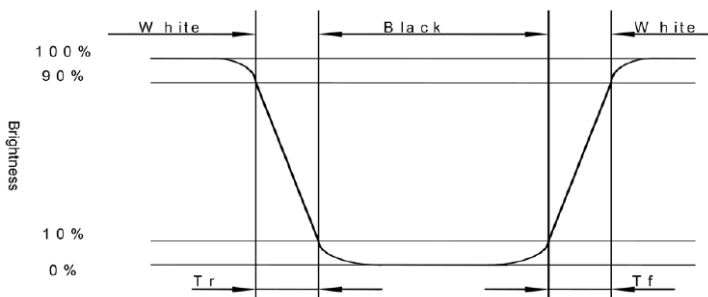

7. Outline Dimension

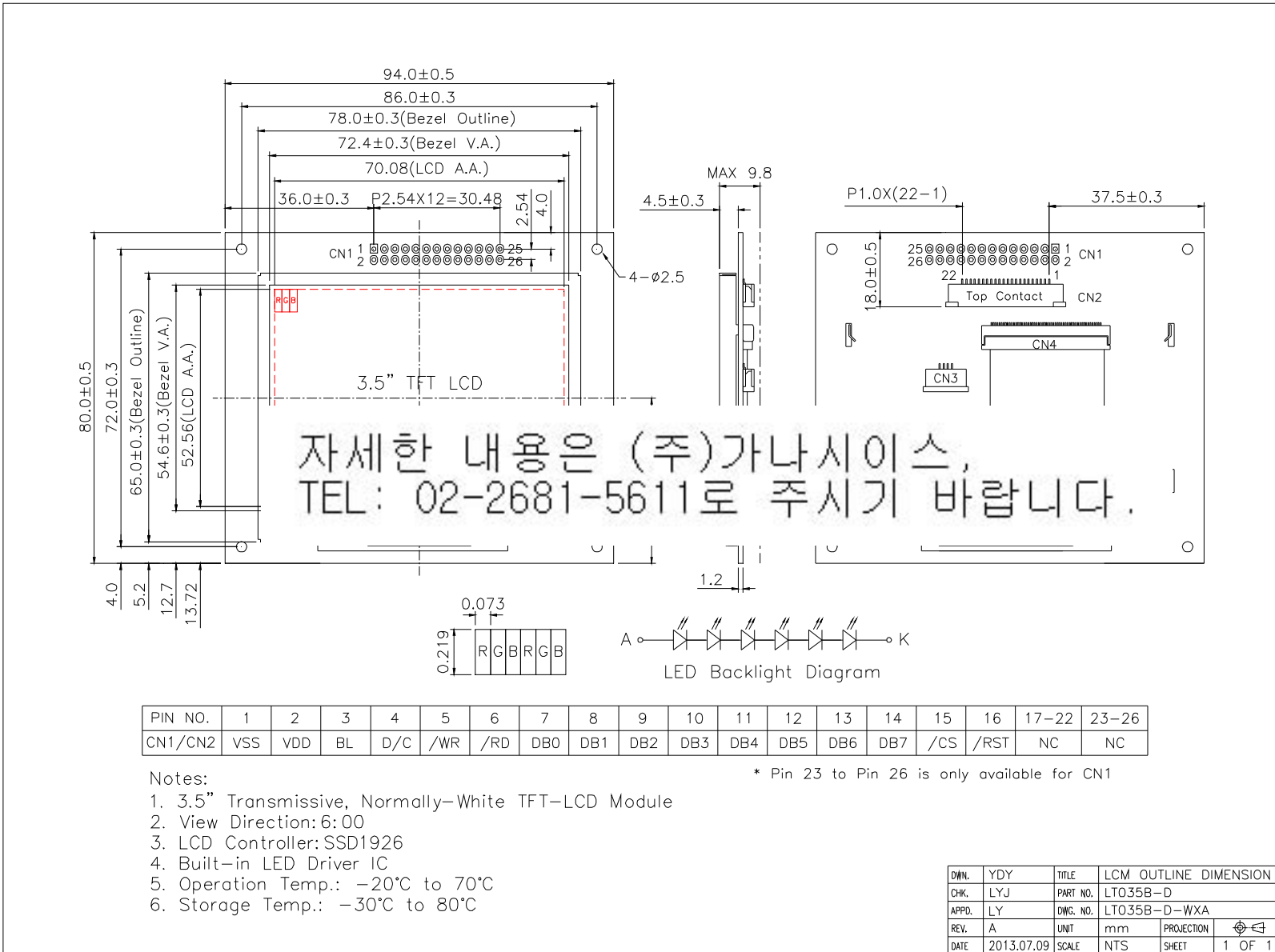

8. Initialization

Below are register values for lcd initialization code.

```
uint code reg_set[48][2] = {
    {0x00a2,0x00},//1 Software Reset Register
    {0x0126,0x0a},//2 PLL Clock Setting Register 0
    {0x0127,0xc8},//3 PLL Clock Setting Register 1
    {0x0004,0x00},//4 Memory Clock Configuration Register
    {0x012b,0xae},//5 PLL Clock Setting Register 2
    {0x0126,0x8a},//6 PLL Clock Setting Register 0
    {0x0158,0xff},//7 PCLK Frequency Ratio Register 0
    {0x0159,0x9f},//8 PCLK Frequency Ratio Register
    {0x015a,0x02},//9 PCLK Frequency Ratio Register 2
    {0x0010,0x71},//10 Panel Type Register
    {0x0011,0x00},//11 MOD Rate Register
    {0x0012,0x32},//12 Horizontal Total Register 1
    {0x0017,0x00},//16 Horizontal Display Period Start Position Register 1
    {0x0018,0x05},//17 Vertical Total Register 0
    {0x0019,0x01},//18 Vertical Total Register 1
    {0x001c,0xef},//19 Vertical Display Period Register 0
    {0x001d,0x00},//20 Vertical Display Period Register 1
    {0x001e,0x13},//21 Vertical Display Period Start Position Register 0
    {0x001f,0x00},//22 Vertical Display Period Start Position Register 1
    {0x0020,0x00},//23 LLINE Pulse With Register
    {0x0021,0x00},//24 LLINE Pulse Start Sub-pixel Position Register
    {0x0022,0x00},//25 LLINE Pulse Start Position Register 0
    {0x0023,0x00},//26 LLINE Pulse Start Position Register 1
    {0x0024,0x80},//27 LFRAME Pulse With Register 1
    {0x0026,0x00},//28 LFRAME Pulse Start Position Register 0
    {0x0027,0x00},//29 LFRAME Pulse Start Position Register 1
    {0x0030,0x00},//30 LFRAME Pulse Start Offset Register 0
    {0x0031,0x00},//31 LFRAME Pulse Start Offset Register 1
    {0x0034,0x00},//32 LFRAME Pulse Stop Offset Register 0

```

자세한 내용은 (주)가나시이스,
TEL: 02-2681-5611로 주시기 바랍니다.

{0x0035,0x00},//33 LFRAME Pulse Stop Offset Register 1
{0x0038,0x01},//34 LSHIFT Polarity Register
{0x0070,0x44},//35 Display Mode Register
{0x0071,0x40},//36 Special Effects Register
{0x0074,0x00},//37 Main Window Display Start Address Register 0
{0x0075,0x00},//38 Main Window Display Start Address Register 1
{0x0076,0x00},//39 Main Window Display Start Address Register 2
{0x0078,0xa0},//40 Main Window Line Address Offset Register 0 // = 320:(32:16bpp) = 160
{0x0079,0x00},//41 Main Window Line Address Offset Register 1
{0x01a4,0xc0},//42 RGB Setting Register
{0x01a5,0x00},//43 PCLK Frequency Ratio Register 2
{0x00ad,0x00},//44 LCD Power Control Register
{0x00a0,0x00},//45 Power Saving Configuration Register
{0x002d,0x80},//46 Display Post-processing Brightness Control Register
{0x002e,0x40},//47 Display Post-processing Contrast Control Register
{0x002f,0x01},//48 Display Post-processing Control Register

};

자세한 내용은 (주)가나시이스,
TEL: 02-2681-5611로 주시기 바랍니다.

9. Precautions for Use of LCD Module

9.1 Handling Precautions

- 1) The display panel is made of glass. Do not subject it to a mechanical shock by dropping it from a high place, etc.
- 2) If the display panel is damaged and the liquid crystal substance inside it leaks out, be sure not to get any in your mouth. If the substance comes into contact with your skin or clothes, promptly wash it off using soap and water.
- 3) Do not apply excessive force on the surface of display or the adjoining areas of LCD module since this may cause the color tone to vary.
- 4) The polarizer covering the display surface of the LCD module is soft and easily scratched. Handle this polarizer carefully.
- 5) If the display surface of LCD module becomes contaminated, blow on the surface and gently wipe it with a soft dry cloth. If it is heavily contaminated, moisten cloth with one of the following solvents.
 - Isopropyl alcohol
 - Ethyl alcoholSolvents other than those mentioned above may damage the polarizer. Especially, do not use the following:
 - Water
 - ...
- 6) 자세한 내용은 (주)가나시이스,
TEL: 02-2681-5611로 주시기 바랍니다. n.
Dis e
- outer case.
- 7) Be sure to avoid any solvent such as flux for soldering never stick to Heat-Seal. Such solvent on Heat-Seal may cause connection problem of heat-Seal and TAB.
- 8) Do not forcibly pull or bend the TAB I/O terminals.
- 9) Do not attempt to disassemble or process the LCD module.
- 10) NC terminal should be open. Do not connect anything.
- 11) If the logic circuit power is off, do not apply the input signals.
- 12) To prevent destruction of the elements by static electricity, be careful to maintain an optimum work environment.
 - Be sure to ground the body when handling the LCD module.
 - Tools required for assembly, such as soldering irons, must be properly grounded.
 - To reduce the amount of static electricity generated, do not conduct assembly and other work under dry conditions.
 - The LCD module is coated with a film to protect the display surface. Exercise care when peeling off this protective film since static electricity may be generated.

9.2 Storage Precautions

- 1) When storing the LCD module, avoid exposure to direct sunlight or to the light of fluorescent lamps and high temperature/high humidity. Whenever possible, the LCD module should be stored in the same conditions in which they were shipped from our company.
- 2) Exercise care to minimize corrosion of the electrodes. Corrosion of the electrodes is accelerated by water droplets or a current flow in a high humidity environment.

9.3 Design Precautions

- 1) The absolute maximum ratings represent the rated value beyond which LCD module can not exceed. When the LCD modules are used in excess of this rated value, their operating characteristics may be adversely affected.
- 2) To prevent the occurrence of erroneous operation caused by noise, attention must be paid to satisfy VIL, VIH specification values, including taking the precaution of using signal cables that are short.
- 3) The liquid crystal display exhibits temperature dependency characteristics. Since recognition of the display becomes difficult when the LCD is used outside its designated operating temperature range, be sure to use the LCD within this range. Also, keep in mind that the LCD driving voltage levels necessary for clear displays will vary according to temperature.
- 4) Sufficiently notice the mutual noise interference occurred by peripheral devices.

5)

6) 자세한 내용은 (주)가나시이스, ☎
by TEL: 02-2681-5611로 주시기 바랍니다. he
op nt

to the LCD Module.

9.4 Others

- 1) Liquid crystals solidify under low temperatures (below the storage temperature range) leading to defective orientation or the generation of air bubbles (black or white). Air bubbles may also be generated if the LCD module is subjected to a strong shock at a low temperature.
- 2) If the LCD modules have been operating for a long time showing the same display patterns, the display patterns may remain on the screen as ghost images and a slight contrast irregularity may also appear. A normal operating status can be regained by suspending use for some time. It should be noted that this phenomenon does not adversely affect performance reliability.
- 3) To minimize the performance degradation of the LCD modules resulting from destruction caused by static electricity, etc., exercise care to avoid touching the following sections when handling the module:
 - Terminal electrode sections.
 - Part of pattern wiring on TAB,